

# Plastepur® Non-mains Sewage and Wastewater Disposal Systems

## Vertically drained sand filter bed with discharge into the surface water network in impermeable soil

(See French Standard NF DTU 64-1)



- 1 DECOMPRESSION obligatory Higher ventilation to roof apex Ø 100 with static exhaust (see booklet A24).
- 2 Main ventilation of the chute column with ventilation hat Ø 100 mm at 1 m minimum from the Higher ventilation.
- 3 Grease extractor SL-SG (optional)
- 4 Inspection chambers SL-RVISIT adjustable to 5 heights, 3 inlets, 1 outlet
- 5 EPURBLOC® or settling tank "Performance" 3 stamped CE with detachable integrated clogging indicator equipped with "Performance" filtering mesh detachable and decay-resistant.

- 6 1.Distribution Box 6 outlets SL-RR adjustable to 5 heights
- 7 AIR INLET lower ventilation of the irrigation system. Looping chamber 6 inlets/outlets SL-RBOU adjustable to 5 heights
- 8 AIR INLET (LV) Lower Ventilation of the collection drains. Vertical collection box SL-RCOLV 1190
- 9 Effluent outlet pipe joined to the ground water system and orientated to spouting direction
- 10 Large plants (trees) at minimum 3m
- 11 Party fence (property limit) at 3m minimum

The aerobic purification installation above can be realized thanks to our kits for Non Drained Filters **Kit FND** and for drained filters **Kit FD**. Find our **Kit FND** and **Kit FD**

### Important:

- \* Minimal distance between the distribution system (irrigation) and property limit (aerobic purification system):  
on flat terrain: distance 3m min • on slope > to 5 %: distance 10m min  
Distance between distribution system and habitation: 5m min.

Distance between the distribution system (irrigation) and bore holes, wells, sources or harvesters of water for human consumption at a minimum of 35m from the treatment facility according to the current local regulations.

Rainwater should never be directed through an independent wastewater disposal system but stored in a recuperation cistern (see doc. EP64 and EP24).

Consult the User's Booklet A24 before any installation of our Principal and Secondary Treatment Units or Accessories

For other systems, consult documents A64

# Plastepur® Sotralentz Systems

## General view of 2 systems

(see French Standard NF DTU 64-1)



**Underground broad irrigation at a low or greater depth, in permeable terrain**

**Vertical flow sand filter with ejection into the surface water system, in impermeable terrain**

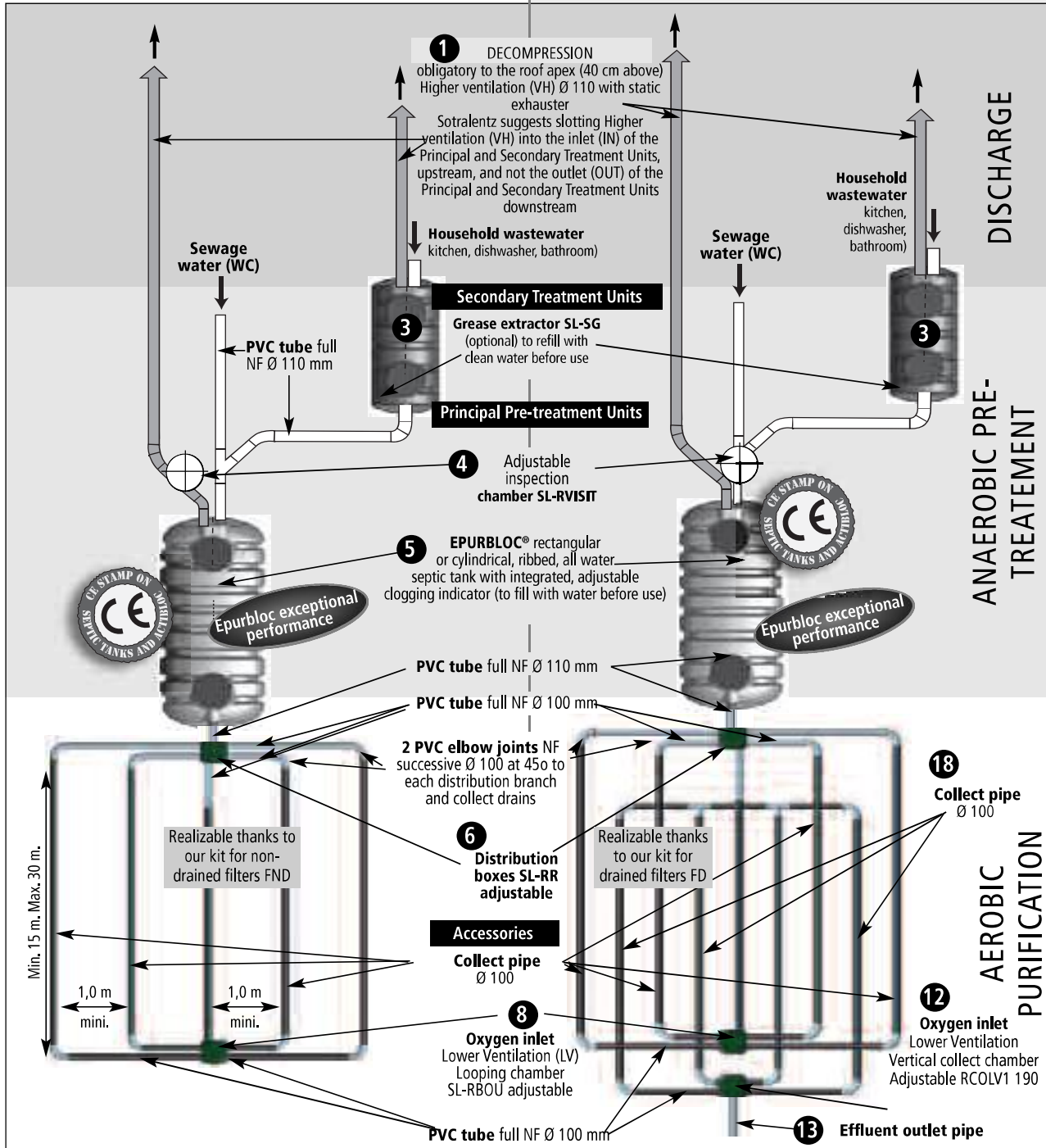

Aerobic purification systems above are now possible with our kits for Drained Filters (**Kit FD**) and non-drained Filters (**Kit FND**)  
Find out **Kit FND** and **Kit FD** in document A64.



# Non-drained Aerobic Purification Systems

The choice of device and system of non-mains waste water disposal is the determined by analyzing the results of soil and terrain test characteristics:

- topology and water seepage capability of the ground
- possible effluent outlets
- usage of the reception site

Remember to complete the 2 "Diagnostic" pages of our Instruction Folder A2 that will help you make your choice

To install non-drained mounds of infiltration and non-drained filter beds, use out non-drained filter kits FND

Kit FND

## Key

### LAND TOPOLOGY AND WATER SEEPAGE CAPACITY

- Grass, herbs
- Vegetation, embankment
- Relatively deep permeable soil
- Relatively thick, highly permeable soil on fissured limestone subsoil
- Hardly permeable soil
- Water on surface or not deep

### ANAEROBIC PRE-TREATMENT

- Concrete, stabilized sand
- Gaseous accumulation (methane) and aggressive agents (sulfurous anhydride)
- Hat (grease, floating matter)
- Sludge bed settling and undergoing anaerobic fermentation
- Waste domestic water (separation and settling zone)
- Filtering mesh "Performance" (anaerobic pre-filtration)
- Pumping station (clean water)
- Higher ventilation (VH) obligatory ( $\varnothing 100\text{mm}$ )
- Looping Higher ventilation VH ( $\varnothing 100\text{mm}$ ) optional is slotting upstream of Pre-treatment Unit
- Eurobloc and clarification unit "Performance"
- Lift pump SL-REL

### AEROBIC PURIFICATION

- Stabilized sand (dry mix  $1\text{m}^3$  sand + 200kg cement)
- Sand
- Sandy-loamy soil
- Fine gravel  $\varnothing 20/40\text{mm}$
- Distribution (irrigation) or collect pipes ( $\varnothing 100$ )
- Non return valve on the effluent outlet
- Geotextile felt ( $63 \mu\text{m} \leq \text{OF} \leq 100 \mu\text{m}$ ) (NF EN 10319, 11058 and 12956)
- Separating geogriid ( $400 \mu\text{m} \leq \text{OF} \leq 600 \mu\text{m}$ ) (NF EN 10319, 11058 and 12956)
- Polyethylene impermeable film  $400 \mu\text{m}$

Finally, there can sometimes be no satisfying solution to independent sewage disposal, and, in the absence of connection to the mains sewer system, it is necessary to abandon the construction or renovation project, as the terrain is unsuitable. Always consult our User Manual A24 for:

- Determination of user number, volume
- All installation instruction of Principal and Secondary Treatment Units and Accessories
- Service and maintenance frequency
- Guarantee information

For description, placement, working, maintenance and guarantees of Principal and Secondary Treatment Units and Accessories, see summary of this User's manual A24 on page 1.

Systems conform to the French Standard NF DTU 64-1

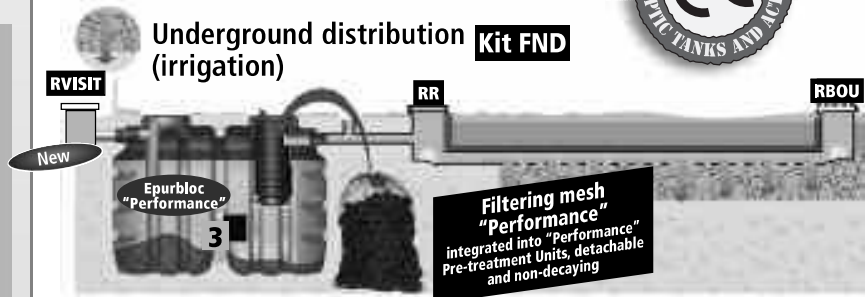

### Shallow irrigation

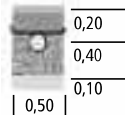

### Irrigation on slopes $\geq 5\%$ and $\leq 10\%$

Cross-section

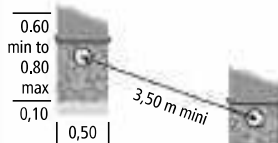

Above

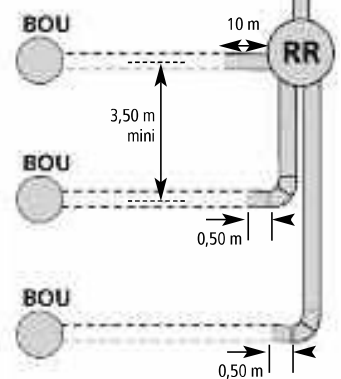

### Deep irrigation

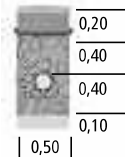

### Shallow, broad irrigation



### Mounds of infiltration Kit FND

above ground Kit FND, underground lakes or in flood zones, with concreted Pre-treatment Units



# Non-drained Aerobic Purification Systems

## 3 Non-drained filter bed made of restored soil (loam-sand layer) **Kit FND**



## 4 Non-drained filter bed made of restored soil (sand layer) **Kit FND**

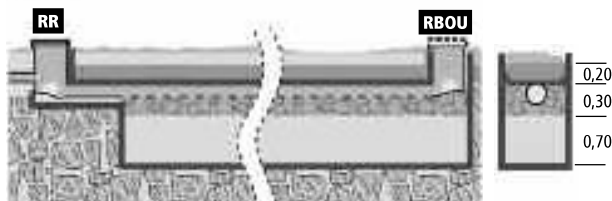

### Accessories: Non-drained Filter Kit **Kit FND** (sold separately)

For the installation of your irrigation systems, your mounds of infiltration, and non-drained filter beds made of restored soil, use our non-drained filter kits **FND Kit FND** of 5 x 4, 5 x 5, 5 x 6, 5 x 7, 5 x 8, 5 x 9, 5 x 10, 5 x 11 and 5m x 12m

#### Including:

- A** 1 Filtroplus geotextile felt
- B** 1 Filtrogrill geogrill
- C** 1 adjustable RR + 8 integrated elbow joints in the 2 chambers
- D** 1 adjustable RBOU + 8 integrated elbow joints in the 2 chambers

Follow our plans **Kit FND**.

### Elevation view of distribution network (irrigation) or filter bed

#### **Kit FND**

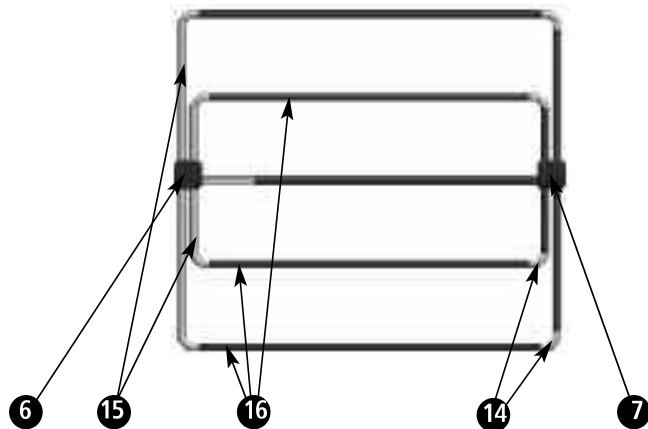

#### NON-DRAINED AEROBIC PURIFICATION

#### **Kit FND**

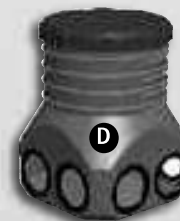

Systems conform to the French Standard NF DTU 64-1

#### Key

- 6** Distribution box RR adjustable to 5 heights with 6 outlets **RR**
- 7** Air Inlet Lower Ventilation (LV) of irrigation Looping chamber RBOU adjustable to 5 heights with 6 inlets/outlets **RBOU**
- 14** 2 successive PVC elbow joints 45° Ø 110
- 15** PVC tube, full Ø 100
- 16** Rigid distribution pipe Ø 100mm





Pipes and piping sold separately.











# Drained Aerobic Purification Systems

## Key









### LAND TOPOLOGY AND WATER SEEPAGE CAPACITY

-  Grass, herbs
-  Vegetation, embankment
-  Impermeable soil
-  Highly impermeable

### ANAEROBIC PRE-TREATMENT

-  Concrete, stabilized sand
-  Gaseous accumulation (methane) and aggressive agents (sulfurous anhydride)
-  Hat (grease, floating matter)
-  Sludge bed settling and undergoing anaerobic fermentation
-  Waste domestic water (separation and settling zone)
-  Filtering mesh "Performance" (anaerobic pre-filtration)
-  Higher ventilation (VH) obligatory (Ø 100mm)
-  Looping Higher ventilation VH (Ø 100mm), optional if upstream slotting of Pre-treatment Unit
- 3** Eurobloc and clarification unit "Performance"
- 4** Pre-filter SL-FD "Performance"
- 7** Lift pump SL-REL
- 9** Compact filter (exceptional cases)

### AEROBIC PURIFICATION

-  Stabilized sand (dry mix 1m<sup>3</sup> sand + 200kg cement)
-  Sand
-  Sandy-loamy soil
-  Fine gravel Ø20/40mm
-  Distribution (irrigation) or collect pipes (Ø 100)
-  Non return valve on the effluent outlet
-  Geotextile felt (63 µm ≤ OF ≤ 100 µm) (NF EN 10319, 11058 and 12956)
-  Separating geogrid (400 µm ≤ OF ≤ 600 µm) (NF EN 10319, 11058 and 12956)

The choice of device and system of independent waste water disposal is the determined by analyzing the results of soil and terrain test characteristics:

- topology and water seepage capability of the ground
- possible effluent outlets
- usage of the reception site

Remember to complete the 2 "Diagnostic" pages of our Instruction Folder A2 that will help you make your choice

Finally, there can sometimes be no satisfying solution to independent sewage disposal, and, in the absence of connection to the mains sewer system, it is necessary to abandon the construction or renovation project, as the terrain is unsuitable.

Consult our User Manual A24 for:

- Determination of user number, volume
- All installation instruction of Principal and Secondary Treatment Units and Accessories
- Service and maintenance frequency
- Guarantee information

For description, placement, working, maintenance and guarantees of Principal and Secondary Treatment Units and Accessories, see summary of this User's manual on page 1.



**For the installation of mounds of infiltration and drained filter beds, use our drained filter kit FD Kit FD**

## Above ground mounds of irrigation Kit FD

On impermeable soil

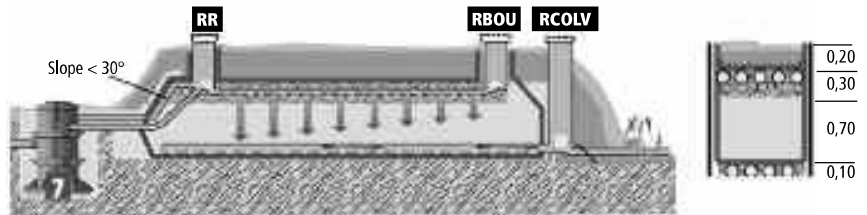

**Systems conform to the French Standard NF DTU 64-1**

## Sand filters with vertical flow Kit FD on impermeable ground with ejection into the surface water system. Kit FD

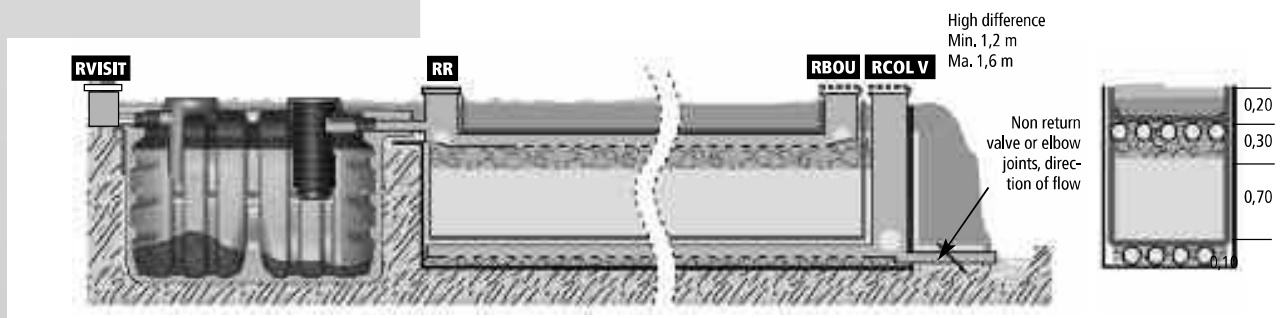

# Drained Aerobic Purification Systems

## Accessories : Drained Filter Kit **Kit FD** (sold separately)

To install your mounds of infiltration and drained filter beds in impermeable soil, use our Drained Filter Kit **Kit FD** of 5 x 4.5, 5 x 5.5, 5 x 6.5, 5 x 7.5, 5 x 8.5, 5 x 9.5, 5 x 10.5, 5 x 11.5 and 5m x 12m, including:

- A** 1 Filtroplus geotextile
- B** 1 Impermeable membrane 400µ
- C** 1 waterproofing collar
- D** 1 Filtrogrill geogrill
- E** 1 adjustable RR + 8 integrated elbow joints in the chamber
- F** 1 adjustable RBOU + 8 integrated elbow joints in the chamber
- G** 1 RCOLV 1190. + 12 elbow joints and 2 T-joints in the chamber

Follow our plans **Kit FD**.

**Kit FD** composed of 2 conditions boxes on 1 pallet  
**Kit FD-1 (Geosynthetics)** and **Kit FD-2 (chambers and joints)**

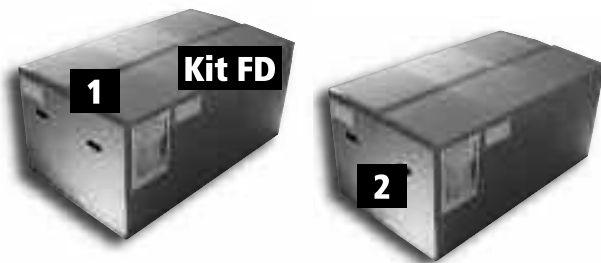

Puncture-resistant Geotextile sold separately in accordance with the size of Kit chosen  
5 x 4, 5 x 5, 5 x 6, 5 x 7,  
5 x 8, 5 x 9, 5 x 10,  
5 x 11 and 5 m x 12 m

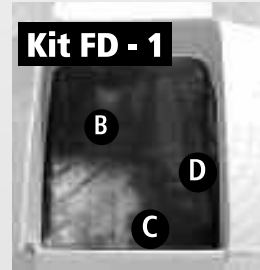
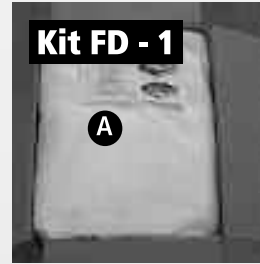

## Elevation view of sand filter with vertical flow

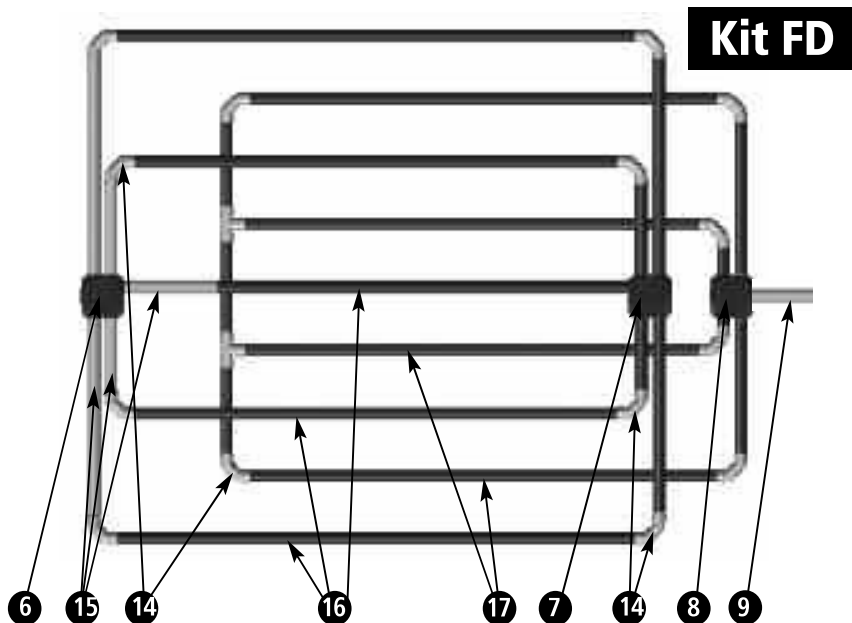

## AEROBIC PURIFICATION WITH VERTICAL FLOW

Systems conform to the French Standard NF DTU 64-1

### Key

- 6** Distribution box RR adjustable 5 heights with 6 outlets **RR**
- 7** Air Inlet Lower Ventilation of irrigation system. 5 heights with 6 inlets/outlets **RBOU**
- 8** Air Inlet Lower Ventilation of vertical collect drains and the vertical collect SL- **RCOLV** 1190 RCOLV
- 9** Effluent outlet pipe, pointing in direction of water flow
- 14** PVC elbow joints 45°, full NF Ø 110
- 15** PVC tube, full NF Ø 110
- 16** Rigid irrigation pipes Ø 100mm
- 17** Collect pipes

Pipes and piping sold separately



**Kit FD**      **Kit FND**

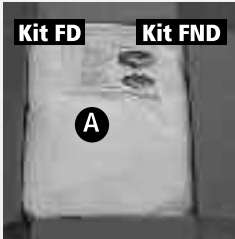

**Kit FD**

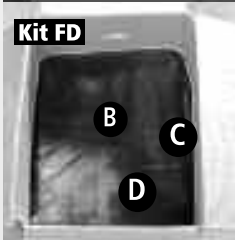

**Kit FND**

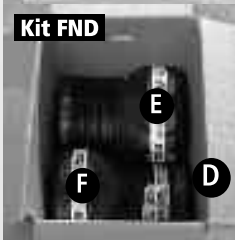

**Kit FD**



# Table for Filter Kits FD and FND

For the installation of mounds of infiltration and drained filter beds  
(sold separately)

Product (meters)	Product Code	Géotextile Filtrplus	Anti-puncture geotextile	Géogrille Filtrgrille	Impermeable membrane	Waterproofing collar	Chamber RR	Chamber RBOU	Chamber RCOLV	Elbow joints Ø 100/45o	T-joints Ø 100/90°
FND 5 x 4	30593	YES	NO	YES	NO	NO	YES	YES	NO	16	NO
FND 5 x 5	30594	YES	NO	YES	NO	NO	YES	YES	NO	16	NO
FND 5 x 6	30595	YES	NO	YES	NO	NO	YES	YES	NO	16	NO
FND 5 x 7	30596	YES	NO	YES	NO	NO	YES	YES	NO	16	NO
FND 5 x 8	32042	YES	NO	YES	NO	NO	YES	YES	NO	16	NO
FND 5 x 9	32043	YES	NO	YES	NO	NO	YES	YES	NO	16	NO
FND 5 x 10	32044	YES	NO	YES	NO	NO	YES	YES	NO	16	NO
FND 5 x 11	32045	YES	NO	YES	NO	NO	YES	YES	NO	16	NO
FND 5 x 12	32046	YES	NO	YES	NO	NO	YES	YES	NO	16	NO
FD 5 x 4	30597	YES	option*	YES	YES	YES	YES	YES	YES	28	2
FD 5 x 5	30598	YES	option*	YES	YES	YES	YES	YES	YES	28	2
FD 5 x 6	30599	YES	option*	YES	YES	YES	YES	YES	YES	28	2
FD 5 x 7	30600	YES	option*	YES	YES	YES	YES	YES	YES	28	2
FD 5 x 8	32047	YES	option*	YES	YES	YES	YES	YES	YES	28	2
FD 5 x 9	32048	YES	option*	YES	YES	YES	YES	YES	YES	28	2
FD 5 x 10	32049	YES	option*	YES	YES	YES	YES	YES	YES	28	2
FD 5 x 11	32050	YES	option*	YES	YES	YES	YES	YES	YES	28	2
FD 5 x 12	32051	YES	option*	YES	YES	YES	YES	YES	YES	28	2

**Kit FD** composed of 2 conditioned boxes on 1 pallet  
\*options: anti-puncture geotextile sold separately in accordance with size of kit chosen

**For installation of mounds of infiltration and drained filter beds on impermeable soil, use:**

**Our drained filter kits FD **Kit FD** and our non-drained filter kits FND **Kit FND** of 5 x 4, 5 x 5, 5 x 6, 5 x 7, 5 x 8, 5 x 9, 5 x 10, 5 x 11, 5 m x 12 m, including:**

- A** 1 Filtrplus geotextile felt
  - B** 1 Impermeable membrane 400µ
  - C** 1 waterproofing collar
  - D** 1 Filtrgrille geogrill
  - E** 1 adjustable RR + 8 integrated elbow joints in the chamber
  - F** 1 adjustable RBOU + 8 integrated elbow joints in the chamber
  - G** 1 RCOLV 1190 + 12 elbow joints and 2 T-joints in the chamber
- = KIT FD-1 Geosynthetic**
- = KIT FD-2 Chambers and Joints**

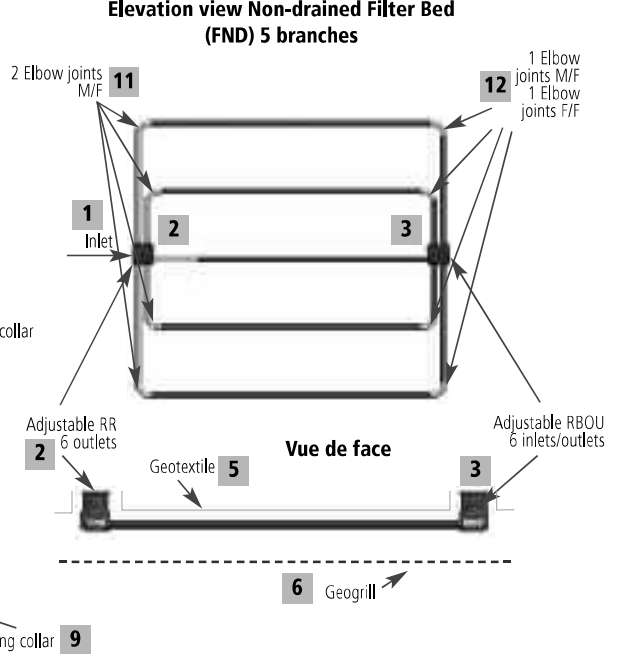
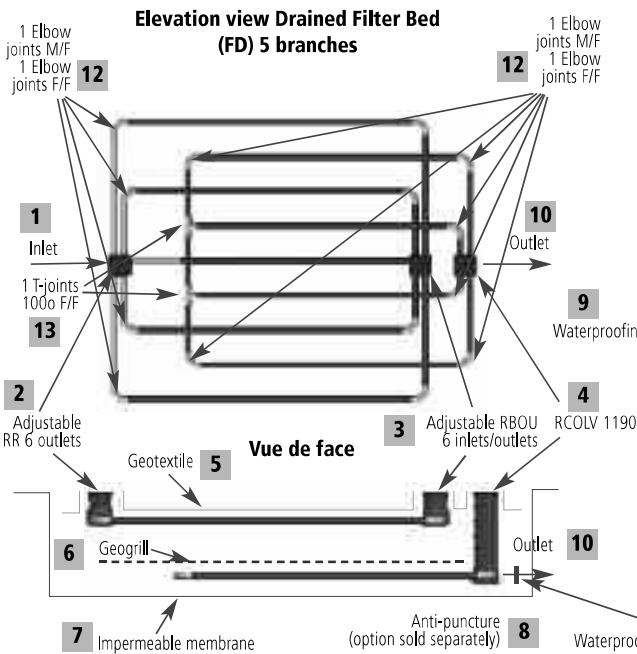

- 1. Inlet of pre-treated wastewater
- 2. Adjustable RR distribution box
- 3. Adjustable RBOU looping chamber
- 4. RCOLV 1190 vertical collect chamber
- 5. Geotextile filtrplus
- 6. Grill filtrgrille
- 7. Impermeable membrane
- 8. Geotextile anti-puncture (option sold separately)
- 9. Waterproof collar for drained filter (FD)
- 10. Outlet of treated wastewater
- 11. 2 elbow joints 45o Ø 100 M/F to glue  
12. 1 elbow joint 45o Ø 100 M/F  
+ 1 elbow joint 45o Ø 100 F/F to glue
- 13. 1 T 90o Ø 100 F/F



# Plastepur® Sotralentz Calculation Parameters

Parameters to calculate the volume of all water septic tanks, settling tanks, of EPURBLOC® and of clarifications tanks with the CE mark.	Establishment	Usage par person	Rate (l/d)	Volume (2) to treat, per user (l)	Grease separation	Solids separation
	Building site or factory, 3 crews per day	3u x 1	340-450	1020-1350	Yes if kitchen	Yes if kitchen
	Building site or factory, 2 crews per jour	2u x 1	225- 300	675- 900	Yes if kitchen	Yes if kitchen
	Hall (1), meeting room, disco, without kitchen (sanitation only)	0.1	15	45	NO	NO
	Hall (1) with kitchen Occasional usage	0.3	45	135	YES	YES
	Occasional user (public places)	0.05	7.5	22.5	NO	NO
	Seasonal camping site (1 emplacement = 3 users)	0.7	105	315	Yes if kitchen	Yes if kitchen
	Permanent camping site (1 emplacement = 3 users)	1	150	450	Yes if kitchen	Yes if kitchen
	Hotel without restaurant (per room)	1	150	450	NO	NO
	Hotel — Restaurant (per room)	2	300	900	YES	YES
	Hospital, clinic (per bed)	3	340 - 450	1020 - 1350	YES	YES
	School (without restaurant), office, shop	0.2	30	90	NO	NO
	School (semi-boarding), restaurant, canteen	0.5	75	225	YES	YES
	Boarding, barracks, Rest home	1	150	450	Yes if kitchen	Yes if kitchen
Permanent user	1	150	450	NO	NO	

To determine dimensions of aerobic purifying elements, conforming to current regulation laws and to the Standard XPDTU 64-1, P 1.1 and P 1.2, March 2007

(1) Specify on the construction permission application the system of wastewater disposal that will be considered, in case of the addition of another kitchen, cooking areas or supplementary rooms  
 (2) volume to pre-treat per user, to know the septic tank capacity necessary for three (3) days. Example : 8 permanent users x 150 l x 3 days = 3 600 litres, or 1 septic tank or EPURBLOC® of 4 000 litres CE mar to install. The minimum allowed volume for an all water septic tank is 3 000 litres.  
 When placing an independent grouped wastewater disposal system, the succession of a settling tank (SL-F5 DC), of a EPURBLOC® or of a clarification tank (SL-CLARIF)  
 CE mark, by a Pre-filter (SL-FD) is authorized. In this case, the settling tank volume must always be above or equal to the EPURBLOC® or a clarification tank placed immediately downstream  
 Remember to not connect certain sorts of Principal Pre-treatment Units to an independent wastewater disposal system.

## Determining user number

The general number of users, per septic tank with large capacity, is determined by the criteria below:

- Hotels-restaurants, barracks, retirement homes, boarding schools, hospitals, camping sites (users x2 if separate sewage treatment)
- Hotels, school with canteen
- Offices, factories and shops, restaurants, schools, halls (covered), sport halls.
- Public spaces, cafes, car parks, public W.C.'s., discos.

Type	1	2	3	4
SL EPURBLOC® 4000 CYL	10	22	44	-
SL EPURBLOC® 5 000 SP-SZ	15	30	60	-
Clarification tank 7 500 SP-SZ	25	50	100	300
Clarification tank 9000 DP-RKT	35	70	140	700





# Threaded riser SL-REHC 400/200 and SL-REHC 600

**Sold separately**

**New** Assembly of threaded riser SL-REHC 400/200

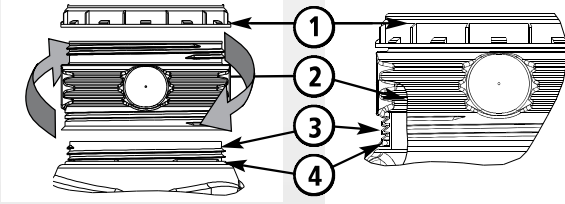

- A- Place supplied watertight joint into the screw thread of the device.
- B- Screw the threaded riser to the device.
- C- Screw the cap onto the riser..

- 1- Screwing caps.
- 2- Threaded riser.
- 3- Screw thread of the device.
- 4- Watertight joint.
- 5- Compartment containing integrated pre-filter clogging indicator removable through the manhole and the riser REHC 400/200.



**Assembly of threaded riser SL-REHC 400/200 and removal of integrated pre-filter clogging indicator through the manhole and the riser**

**REHC 400/200**

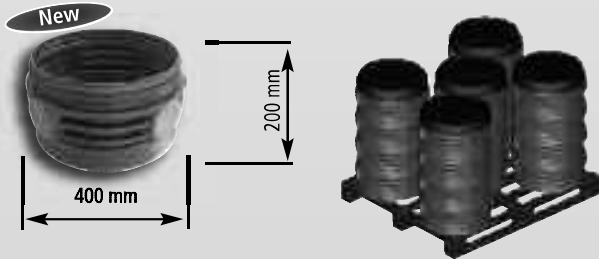

Option: Child safety device in stainless steel (sold separately) adaptable to all screwing PEHD caps.

## Placement

See Standard NF DTU 64-1 and assembly diagram

Type	Article	Exterior diameter (mm)	Height (mm)	Cap
<b>New</b> REHC D400H200	34312	400	200	NO
<b>New</b> REHC D600H150	31369	600	150	NO
REHC D600H250	32233	600	250	NO
<b>New</b> REHC D600H300	31370	600	300	NO
REHC D600H800 RKT + TAMPON	30881	600	adjustable to 1 height from 750 to 600	YES
Reinforced screwing cap (sold separately)	30880	600		Adaptable to the risers REHC 600/150, 250 and 300

NB: threaded riser REHC 400/200 • available individually or by the pallet of 20  
• Adaptable to the majority of Plastepur® Principal and Secondary Treatment Units.

**REHC 600 CR**

Riser REHC 600 CR for the models SPRKT and Double Skin® RKT adjustable to 1 height, from 750 to 600 mm. Delivered with reinforced cap for use in public areas.

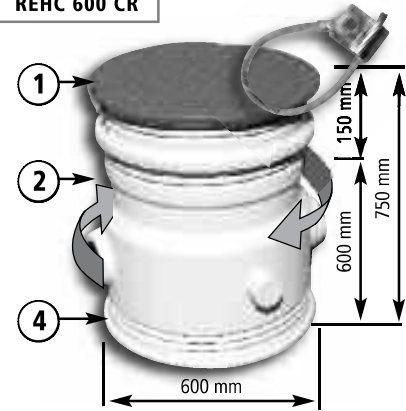

**REHC 600/250**

**Reinforced cap**

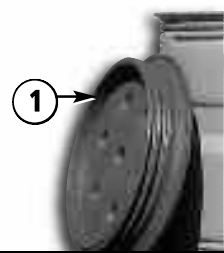

**REHC 600/150**

**New**

**REHC 600/300**

**New**



**REHC 600/150 and REHC 600/300 are adaptable, by screwing, to REHC 600 CR and REHC 600/250 by carefully respecting special installations.**

# Rectangular, ribbed Plastepur® septic tanks

1 000 l., 1 500 l. and 2 000 l.

Sewage-only septic tanks are uniquely authorized by exception during the rehabilitation of an existing separate treatment system

## Workings of a sewage-only septic tank 1000l

### Cross-section

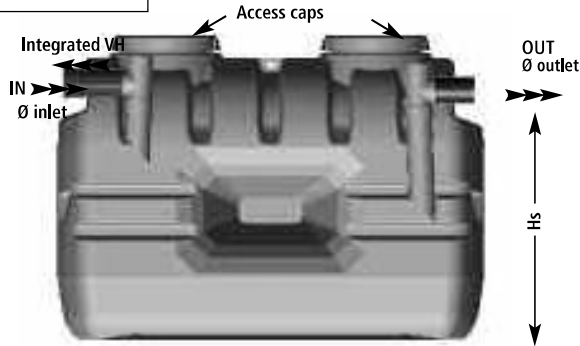

## Sewage-only septic tank 1500l



REHC 400/200 threaded riser adaptable to all manholes Ø 400mm, sold separately

### Below



## Workings of EPURBLOC® 1500 l (all water version for 3 users or equivalent, maximum)

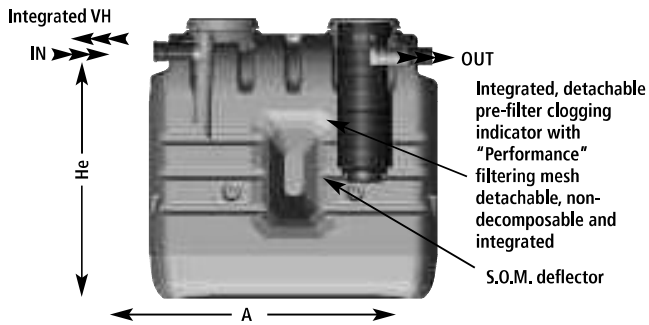

### Inlet Side (IN)

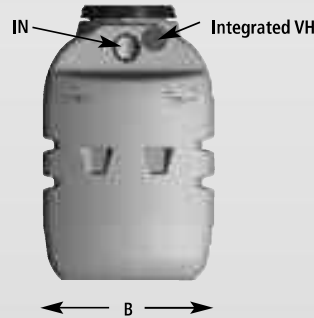

### Outlet Side (OUT)



## Workings of EPURBLOC® 2000 l (all water version for 4 users or equivalent)



rectangular, ribbed EPURBLOC® 2000 one of the highest performers on the market: pit tests in wet soil with 0.60m above the water table in the version Perfwater with "Plantco" fixation.

### Cross-section

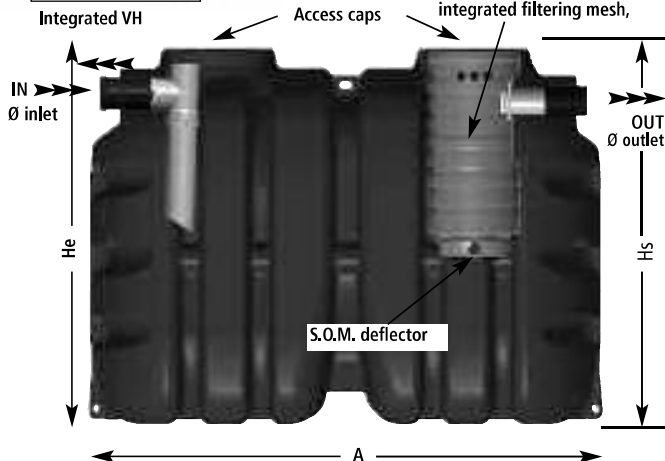

### Inlet Side (IN)



### Outlet Side (OUT)



### Below



# Plastepur® ribbed rectangular septic tanks 3000

(patented model. Septic tank, settling units, Epurbloc® All Water)

**Workings principle of Epurbloc® 3000 ribbed, rectangular**



**Ribbed rectangular Epurbloc® 3000**  
 one of the highest performers on the market: pit tests in wet soil with 0.60m above the water table in the version "Perfwater" with "Plantco" fixation

**Cross-section**

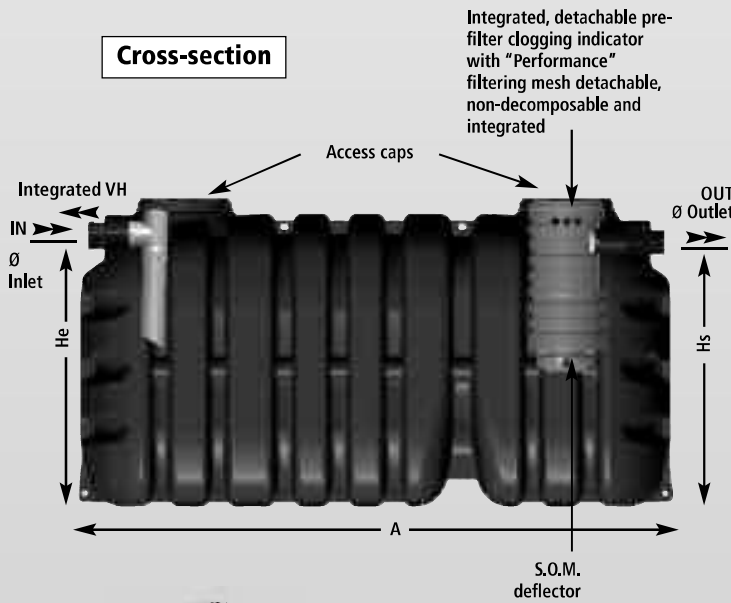

**Inlet Side (IN)**

**Outlet Side (OUT)**

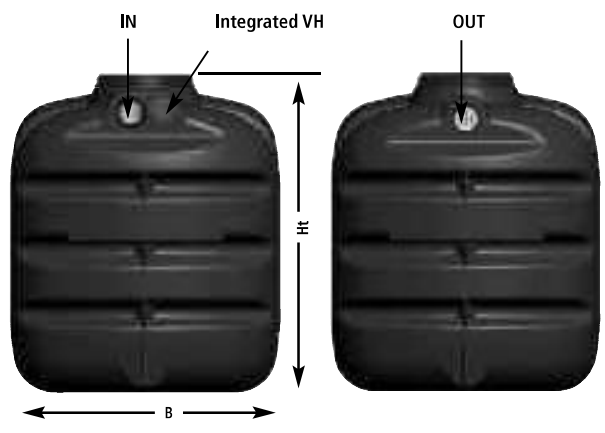

**Below**



# Cylindrical ribbed septic tanks 4000l

(patented model. Septic tank, settling units, Epurbloc® All Water)

## Workings of Epurbloc® 4000l Cylindrical, ribbed



## Face

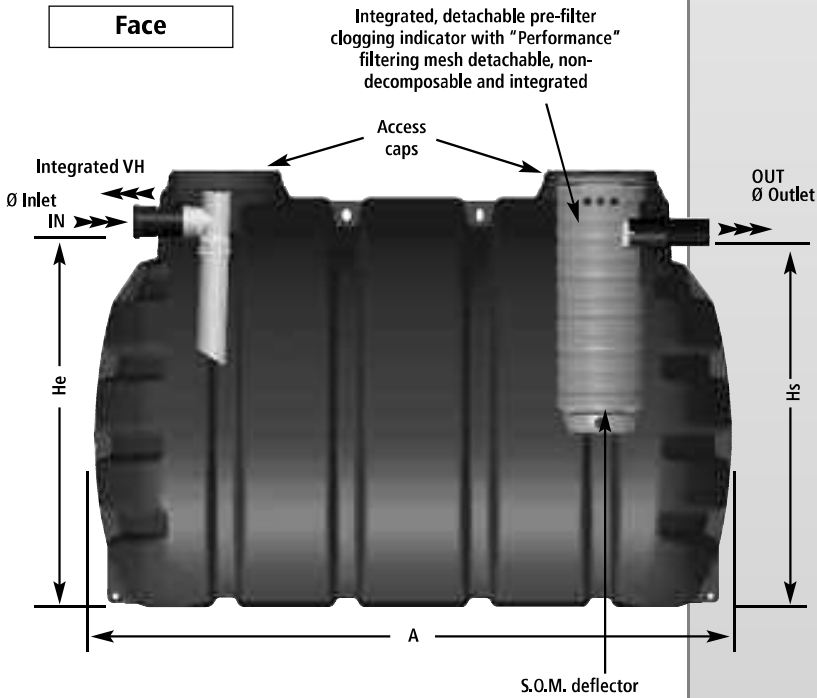

## Inlet Side (IN)

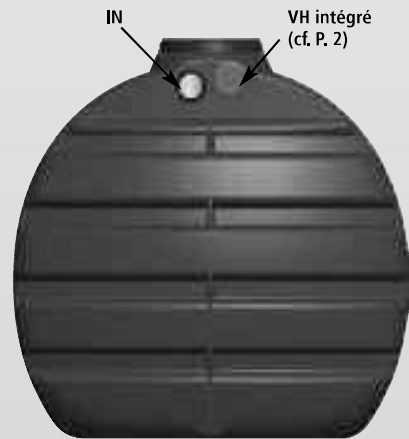

## Côté Sortie (OUT)

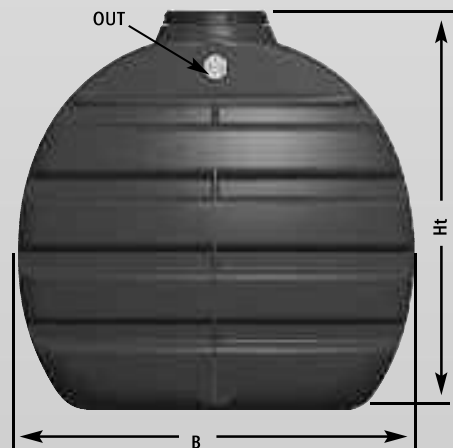

# Septic tanks, settling tanks and Epurbloc® descriptions



## Rectangular, ribbed Plastepur®

	Article	Monobloc cistern	Rectangular	extrusion blowmoulding High Density Polyethylene (PEHD)	New inlet baffle (IN) to de-clog and decompress	Outlet baffle (OUT)	New detachable, integrated pre-filter (OUT) clogging indicator	Boss(es)	Integrated Carrying handles	Slotting to Upper Ventilation (VH Ø 100)	
Sewage only	DECANTEUR 1000 SP D110 RECT	11634	YES	YES	YES	NO	YES	NO	1	YES	YES
	DECANTEUR 1500 SP D110 RECT	11636	YES	YES	YES	NO	YES	NO	1	YES	YES
All-Water	EPUR. 1500R. D110 PERF	31988	YES	YES	YES	YES	NO	YES	1	YES	YES
	EPUR. 2000R. D110 PERF	24371	YES	YES	YES	YES	NO	YES	2	YES	YES
	EPUR. 3000R. D110 PERF	24372	YES	YES	YES	YES	NO	YES	2	YES	YES

Approximate values

	Article	Main parts	User number	Weight (kg)	Diameter Ø (mm) of inlet and outlet	Length A (cm)	Width B (cm)	Height total Ht (cm)	Height inlet He (cm)	Height outlet Hs (cm)	Visit caps (mm)	Placement above ground		Detachable, integrated pre-filter clogging indicator (OUT)	"Performance" filtrating mesh
												Height retaining wall (cm)	Height sand (cm)		
Sewage only	DECANTEUR 1000 SP D110 RECT	1 à 4	8	42	110	170	77	123	100	97	2 x Ø 400	60	50	NO	NO
	DECANTEUR 1500 SP D110 RECT	5 à 6	12	64	110	170	77	166	143	140	2 x Ø 400	60	50	NO	NO
All-Water	EPUR. 1500R. D110 PERF	1 à 2	3	64	110	170	77	166	143	140	2 x Ø 400	60	50	YES	YES
	EPUR. 2000R. D110 PERF	1 à 4	4	92	110	190	119	144	118	115	2 x Ø 400	60	50	YES	YES
	EPUR. 3000R. D110 PERF	5	6	119	110	270	119	144	118	115	2 x Ø 400	60	50	YES	YES

Approximate values

Option: threaded riser REHC 400/200 adaptable to inlet and outlets on all Principal Pre-treatment Units.

## Cylindrical ribbed Plastepur®

	Article	Monobloc cistern	Cylindrical ribbed	extrusion blowmoulding High Density Polyethylene (PEHD)	New inlet baffle (IN) to de-clog and decompress	New detachable, integrated pre-filter (OUT) clogging indicator	Lifting ring )	Integrated Carrying handles	Slotting to Upper Ventilation (VH Ø 100)
All-Water	EPUR. 4000C. D110 PERF	24374	YES	YES	YES	2	2	YES	YES

Approximate values

	Article	Principal parts	User (equivalent)	Weight (kg)	Diameter Ø (mm) Inlet and Outlet	Length A (cm)	Breadth B (cm)	Total height Ht (cm)	Inlet height He (cm)	Outlet height Hs (cm)	Aeration height (cm)	Access caps (mm)	Placement above ground		Detachable, integrated pre-filter clogging indicator "Performance"	filtrating mesh	
													Height retaining wall H (m)	Height sand h (m)			
All-Water	EPUR. 4000C. D110 PERF	24374	6	8	140	110	239	165	165	140	136	144	2 x Ø 400	80	70	AVEC	OUI

Approximate values

Option: threaded riser REHC 400/200 adaptable to inlet and outlets on all Principal Pre-treatment Units.

# Septic tanks, settling tanks, Epurbloc® and clarification tanks Single Skin (SP-SZ 5000, 7500 and 10000 l.)

## Workings of Epurbloc® All Water SP-SZ 5000l

Face

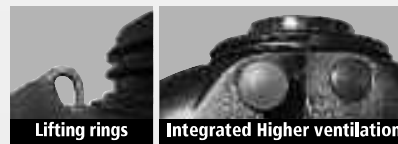
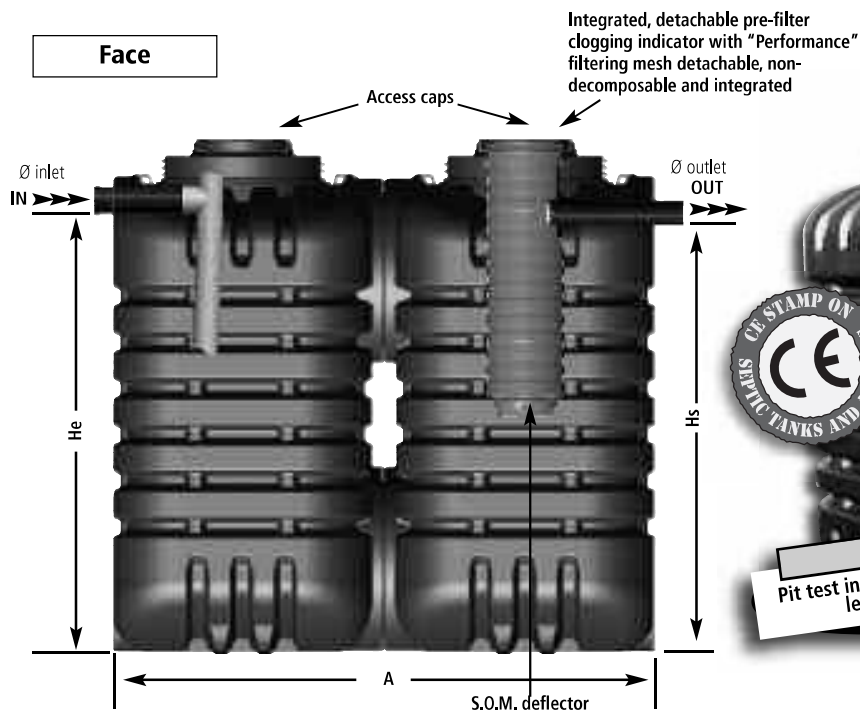

Single Skin Cistern  
Pit test in wet soil with 0.95m above water level in version "Perfwater"



New

REHC 400/200

REHC 400/200 threaded riser adaptable to all manholes Ø 400mm, sold separately



Threaded riser REHC 600/250

Threaded riser + reinforced cap adaptable to all manholes Ø 600mm, sold separately



## EXECUTION EPURBLOC SP-SZ 10 000 l.

Face

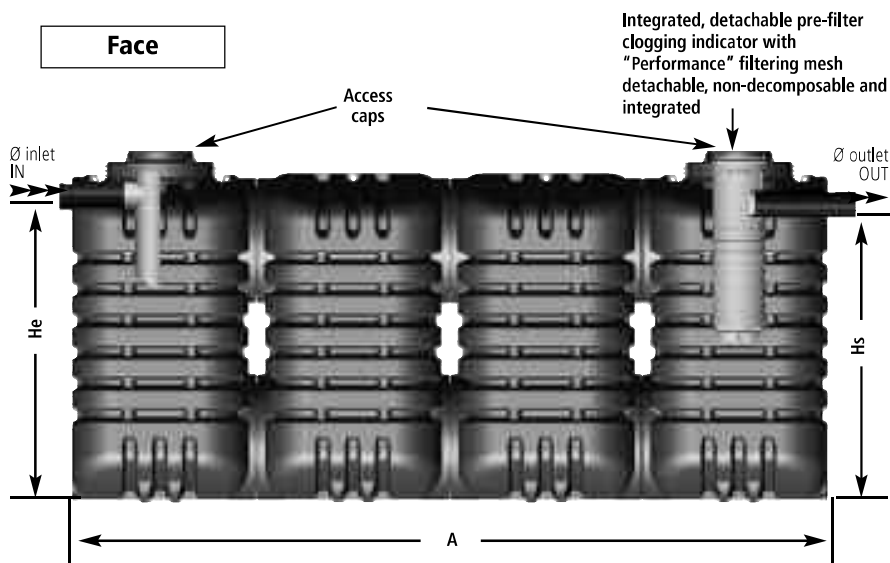

## Side of Principal Pre-treatment Units 5000, 7500 and 10000l

